

## CSN500 - July 23, 2021

Item # CSN500 was discontinued on July 23, 2021. For informational purposes, this is a copy of the website content at that time and is valid only for the stated product.

### OBJECTIVE MOUNTING FOR DIY CERNA® SYSTEMS

- ▶ Single-, Dual-, or Quintuple-Objective Holders
- ▶ Focusing Modules with 1" Travel Range
- ▶ Piezo Objective Scanner for High-Speed Z-Stack Acquisition



**CSN100**  
Single-Objective Nosepiece



**CSN500**  
Quintuple-Objective  
Nosepiece



**PFM450E**  
Piezo Objective Scanner  
(Controller Included)



**CSN210**  
Motorized, Dual-Objective Nosepiece



**ZFM2020**  
Motorized Focusing Module



**Application Idea**  
A CSN1202 Manual Retracting, Dual-Objective Nosepiece is Shown with Two Objectives Mounted

[Hide Overview](#)

#### OVERVIEW

##### Features

- Place Objectives at 7.74" Throat Depth of DIY Cerna® Microscope
- Variety of Threads for Objective Mounting
- Nosepieces for 1, 2, or 5 Objectives
- Motorized, Dual-Objective Nosepiece for Easy Objective Changing
- Piezo-Actuated Objective Scanner for High-Frame-Rate Z-Stack Acquisition
  - Adapters (Sold Separately) Support a Variety of Standard Microscope and Objective Threads
- Macro Lens Nosepiece with Internal SM2 (2.035"-40) Threads
- 60 mm Cage System Compatibility on Select Nosepieces
- Motorized Focusing Modules with 1" of Z-Travel Secure Nosepieces to Microscope Body



Click to Enlarge  
The Mounting Arms for  
Our Nosepieces  
Contain Six M4  
Counterbores for  
Mounting Them to Our  
Focusing Modules

Thorlabs' selection of objective holders provides a variety of mechanical interfaces for mounting microscope objectives and other optical elements along the optical path of a DIY Cerna system. Our current offering includes single-objective, dual-objective, and quintuple-objective nosepieces. We have a motorized, dual-objective nosepiece with a precision servo motor, as well as single-objective and dual-objective nosepieces that have slots for DIC objective prisms. In addition, we manufacture a nosepiece with internal SM2 (2.035"-40) threads and taps for a 60 mm cage system, which can be used to mount macro lenses and a wide variety of Thorlabs optomechanics.

Thorlabs also offers two motorized fine focusing modules (available below), which provide 1" of travel along the Z-axis and connect objective nosepieces and arms to the microscope body. The ZFM2020 and ZFM2030 facilitate flexibility in the mounting configuration. These modules can be driven using the MCM3001 3-Axis Controller. (sold separately)



Click to Enlarge  
This system uses our CSN200  
Dual-Objective Nosepiece,  
BSA2000 Condenser Arm, and  
ZFM2020 and ZFM2030  
Focusing Modules to mount  
and motorize an objective and  
condenser.

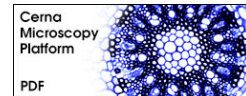

Cerna  
Microscopy  
Platform  
PDF

Additional body attachments and extensions are available which allow the integration of Thorlabs' lens tube systems, cage construction systems, and other optomechanics with our Cerna microscopy platform. We also offer condenser arms that are designed to mount condensers at the 7.74" throat depth of DIY Cerna systems. For optics that do not require frequent adjustment, we also offer fixed mounting arms that mount lens tubes and cage systems directly along the optical path of the microscope.

**M I C R O S C O P E D O V E T A I L S**

**Introduction to Microscope Dovetails**

Dovetails are used for mechanical mating and optical port alignment of microscope components. Components are connected by inserting one dovetail into another, then tightening one or more locking setscrews on the female dovetail. Dovetails come in two shapes: linear and circular. Linear dovetails allow the mating components to slide before being locked down, providing flexible positioning options while limiting unneeded degrees of freedom. Circular dovetails align optical ports on different components, maintaining a single optical axis with minimal user intervention.



Click to Enlarge  
This photo shows the male 95 mm dovetail on the microscope body and the female 95 mm dovetail on the CSA1002 Fixed Arm.



Click to Enlarge  
This photo shows the male D1N dovetail on the trinoculars next to the female D1N dovetail on the epi-illumination arm.

Thorlabs Dovetail Reference <sup>a</sup>			
Type	Shape	Outer Dimension	Angle
95 mm	Linear	95 mm	45°
D1N	Circular	Ø2.018"	60°
D2N <sup>b</sup>	Circular	Ø1.50"	90°
D2NB <sup>b</sup>	Circular	Ø1.50"	90°
D3N	Circular	Ø45 mm	70°
D5N	Circular	Ø1.58"	90°
D6N	Circular	Ø1.90"	90°
D7N	Circular	Ø2.05"	90°
D1T	Circular	Ø1.50"	60°
D3T	Circular	Ø1.65"	90°
D1Y	Circular	Ø107 mm	60°
D2Y	Circular	Ø2.32"	50°
D3Y	Circular	Ø1.75"	90°
D4Y	Circular	Ø56 mm	60°
D5Y	Circular	Ø46 mm	60°
D6Y	Circular	Ø41.9 mm	45°
D1Z	Circular	Ø54 mm	60°
D2Z	Circular	Ø57 mm	60°
D3Z	Circular	Ø54 mm	45°

Thorlabs manufactures many components which use dovetails to mate with our own components or those of other manufacturers. To make it easier to identify dovetail compatibility, we have developed a set of dovetail designations. The naming convention of these designations is used only by Thorlabs and not other microscope manufacturers. The table to the right lists all the dovetails Thorlabs makes, along with their key dimensions.

In the case of Thorlabs' Cerna<sup>®</sup> microscopes, different dovetail types are used on different sections of the microscope to ensure that only compatible components can be mated. For example, our WFA2002 Epi-Illuminator Module has a male D1N dovetail that mates with the female D1N dovetail on the microscope body's epi-illumination arm, while the CSS2001 XY Microscopy Stage has a female D1Y dovetail that mates with the male D1Y dovetail on the CSA1051 Mounting Arm.

To learn which dovetail type(s) are on a particular component, consult its mechanical drawing, available by clicking on the red Docs icon (📄) below. For adapters with a female dovetail, the drawing also indicates the size of the hex key needed for the locking setscrew(s). It is important to note that mechanical compatibility does not ensure optical compatibility. Information on optical compatibility is available from Thorlabs' web presentations.

For customers interested in machining their own dovetails, the table to the right gives the outer diameter and angle (as defined by the drawings below) of each Thorlabs dovetail designation. However, the dovetail's height must be determined by the user, and for circular dovetails, the user must also determine the inner diameter and bore diameter. These quantities can vary for dovetails of the same type. One can use the intended mating part to verify compatibility.

In order to reduce wear and simplify connections, dovetails are often machined with chamfers, recesses, and other mechanical features. Some examples of these variations are shown by the drawings below.

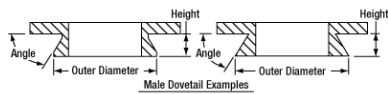

Male Dovetail Examples  
Click to Enlarge  
Two examples of how circular male dovetails can be manufactured.

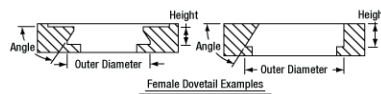

Female Dovetail Examples  
Click to Enlarge  
Two examples of how circular female dovetails can be manufactured.

- a. These dovetail designations are specific to Thorlabs products and are not used by other microscope manufacturers.
- b. D2N and D2NB dovetails have the same outer diameter and angle, as defined by the drawings below. The D2N designation does not specify a height. The D2NB designation specifies a dovetail height of 0.40" (10.2 mm).

**D I Y C E R N A I N T E R F A C E S**

**Standard Mechanical Interfaces on DIY Cerna<sup>®</sup> Components**

The table below gives the dovetail, optical component threads, and cage system interfaces that are present on each DIY Cerna component. If a DIY Cerna component does not have one of the standard interfaces in the table, it is not listed here. Please note that mechanical compatibility does not ensure optical compatibility. Information on optical compatibility is available from Thorlabs' web presentations.

Item #	Microscope Dovetails										Optical Component Threads <sup>a</sup>				Cage Systems <sup>b</sup>	
	95 mm	D1N	D2N	D2NB	D3N	D5N	D1T	D3T	D1Y	D5Y	C-Mount <sup>c</sup> (1.00"-32)	SM1 <sup>d</sup> (1.035"-40)	SM30 (M30.5x0.5)	SM2 <sup>e</sup> (2.035"-40)	30 mm <sup>d</sup>	60 mm <sup>e</sup>
2CM1												Internal & External		Internal		Yes
2CM2												Internal &		Internal	Yes	



WFA0150	Female																
WFA1000																	Yes
WFA1010												Internal					Yes
WFA1020												Internal					Yes
WFA1051												Internal					Yes
WFA1100																	Yes
WFA2001		Male & Female											Internal & External				
WFA2002		Male & Female											Internal				Yes
WFA4002		Male				Female											
WFA4100		Male										External	Internal				
WFA4101		Male										External	Internal				
WFA4102		Male										External	Internal				
WFA4105			Male									External					
WFA4106			Male									External					
WFA4108						Male						External					
WFA4110		Male														External	
WFA4111		Male														External	
WFA4112				Male								External					
<b>Item #</b>	<b>95 mm</b>	<b>D1N</b>	<b>D2N</b>	<b>D2NB</b>	<b>D3N</b>	<b>D5N</b>	<b>D1T</b>	<b>D3T</b>	<b>D1Y</b>	<b>D5Y</b>	<b>C-Mount</b>	<b>SM1</b>	<b>SM30</b>	<b>SM2</b>	<b>30 mm</b>	<b>60 mm</b>	
XT95RC1(/M)	Female																
XT95RC2(/M)	Female																
XT95RC3(/M)	Female																
XT95RC4(/M)	Female																
XT95P12(/M)	Female																
ZFM1020	Female																
ZFM1030	Female																
ZFM2020	Female																
ZFM2030	Female																

- a. Thorlabs' optical component thread adapters can be used to convert between C-Mount threads, SM1 threads, SM2 threads, and virtually every other optical thread standard.
- b. Our cage system size adapters and drop-in adapter can be used to convert between 16 mm, 30 mm, and 60 mm cage systems.
- c. C-Mount and CS-Mount standards feature the same 1.00"-32 threads, but C-Mounts have a 5 mm longer flange-to-sensor distance.
- d. Our 30 mm cage plates can convert between SM1 lens tubes and 30 mm cage systems.
- e. Our 60 mm cage plates can convert between SM2 lens tubes and 60 mm cage systems.
- f. Attach to a ZFM focusing module to add a female 95 mm dovetail.
- g. The CSA1200 mounting arm is compatible with the CSN1201 and CSN1202 nosepieces.
- h. This blank arm is designed for custom DIY machining for non-standard components, threads, and bores..
- i. This nosepiece directly accepts M32 x 0.75 objective threads.
- j. This nosepiece directly accepts M25 x 0.75 objective threads.
- k. This nosepiece directly accepts RMS (0.800"-36) objective threads.

[Hide Cerna Videos](#)

## CERNA VIDEOS

### Building a Cerna® Microscope

The Cerna microscopy platform's large working volume and system of dovetails make it straightforward to connect and position the components of the microscope. This flexibility enables simple and stable set up of a preconfigured microscope, and provides easy paths for later upgrades and modification. See below for a couple examples of the assembly of preconfigured and DIY Cerna microscopes.

### Preconfigured Microscope Kit Design and Assembly

#### Microscope Kit 4 Assembly

The D1N and D2N circular dovetails align the sample viewing and illumination apparatus along the optical path. The microscope body's 95 mm linear dovetail is used to secure the objective mounts and condenser mounts, as well as the transmitted light illumination module. The dovetail allows

## DIY Cerna Design and Assembly

[Hide Microscope Guide](#)

### M I C R O S C O P E   G U I D E

#### Elements of a Microscope

This overview was developed to provide a general understanding of a Cerna® microscope. Click on the different portions of the microscope graphic to the right or use the links below to learn how a Cerna microscope visualizes a sample.

- Terminology
- Microscope Body
- Illumination
- Sample Viewing/Recording
- Sample/Experiment Mounting

#### Terminology

**Arm:** Holds components in the optical path of the microscope.

**Bayonet Mount:** A form of mechanical attachment with tabs on the male end that fit into L-shaped slots on the female end.

**Bellows:** A tube with accordion-shaped rubber sides for a flexible, light-tight extension between the microscope body and the objective.

**Breadboard:** A flat structure with regularly spaced tapped holes for DIY construction.

**Dovetail:** A form of mechanical attachment for many microscopy components. A linear dovetail allows flexible positioning along one dimension before being locked down, while a circular dovetail secures the component in one position. See the *Microscope Dovetails* tab or here for details.

**Epi-Illumination:** Illumination on the same side of the sample as the viewing apparatus. Epi-fluorescence, reflected light, and confocal microscopy are some examples of imaging modalities that utilize epi-illumination.

**Filter Cube:** A cube that holds filters and other optical elements at the correct orientations for microscopy. For example, filter cubes are essential for fluorescence microscopy and reflected light microscopy.

**Köhler Illumination:** A method of illumination that utilizes various optical elements to defocus and flatten the intensity of light across the field of view in the sample plane. A condenser and light collimator are necessary for this technique.

**Nosepiece:** A type of arm used to hold the microscope objective in the optical path of the microscope.

**Optical Path:** The path light follows through the microscope.

**Rail Height:** The height of the support rail of the microscope body.

**Throat Depth:** The distance from the vertical portion of the optical path to the edge of the support rail of the microscope body. The size of the throat depth, along with the working height, determine the working space available for microscopy.

**Trans-Illumination:** Illumination on the opposite side of the sample as the viewing apparatus. Brightfield, differential interference contrast (DIC), Dodt gradient contrast, and darkfield microscopy are some examples of imaging modalities that utilize trans-illumination.

**Working Height:** The height of the support rail of the microscope body plus the height of the base. The size of the working height, along with the throat depth, determine the working space available for microscopy.

Click on the different parts of the microscope to explore their functions.

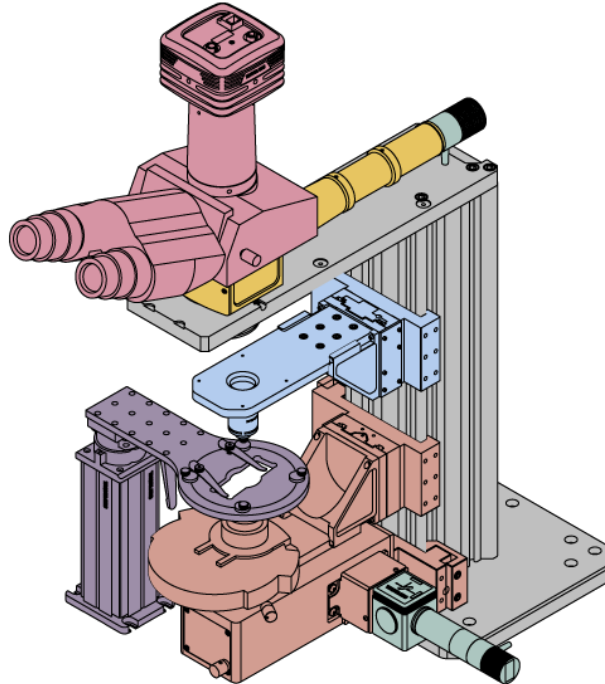

## Microscope Body

The microscope body provides the foundation of any Cerna microscope. The support rail utilizes 95 mm rails machined to a high angular tolerance to ensure an aligned optical path and perpendicularity with the optical table. The support rail height chosen (350 - 600 mm) determines the vertical range available for experiments and microscopy components. The 7.74" throat depth, or distance from the optical path to the support rail, provides a large working space for experiments. Components attach to the body by way of either a linear dovetail on the support rail, or a circular dovetail on the epi-illumination arm (on certain models). Please see the *Microscope Dovetails* tab or here for further details.

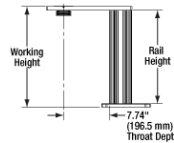

Click to Enlarge  
Body Details

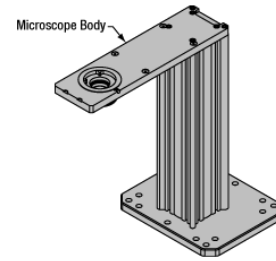

Enlarge  
Cerna Microscope Body

Click to

Microscope Bodies	Microscope Translator

## Illumination

Using the Cerna microscope body, a sample can be illuminated in two directions: from above (epi-illumination, see yellow components to the right) or from below (trans-illumination, see orange components to the right).

Epi-illumination illuminates on the same side of the sample as the viewing apparatus; therefore, the light from the illumination source (green) and the light from the sample plane share a portion of the optical path. It is used in fluorescence, confocal, and reflected light microscopy. Epi-illumination modules, which direct and condition light along the optical path, are attached to the epi-illumination arm of the microscope body via a circular D1N dovetail (see the *Microscope Dovetails* tab or here for details). Multiple epi-illumination modules are available, as well as breadboard tops, which have regularly spaced tapped holes for custom designs.

Trans-illumination illuminates from the opposite side of the sample as the viewing apparatus. Example imaging modalities include brightfield, differential interference contrast (DIC), Dodt gradient contrast, oblique, and darkfield microscopy. Trans-illumination modules, which condition light (on certain models) and direct it along the optical path, are attached to the support rail of the microscope body via a linear dovetail (see *Microscope Dovetails* tab or here). Please note that certain imaging modalities will require additional optics to alter the properties of the beam; these optics may be easily incorporated in the optical path via lens tubes and cage systems. In addition, Thorlabs offers condensers, which reshape input collimated light to help create optimal Köhler illumination. These attach to a mounting arm, which holds the condenser at the throat depth, or the distance from the optical path to the support rail. The arm attaches to a focusing module, used for aligning the condenser with respect to the sample and trans-illumination module.

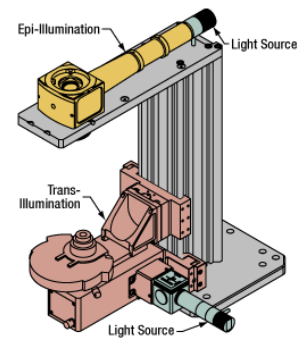

Enlarge

Click to  
Illumination with a Cerna microscope can come from above (yellow) or below (orange). Illumination sources (green) attach to either.

Epi-Illumination Modules	Breadboards & Body Attachments	Brightfield	DIC	Dodt	Condensers	Condenser Mounting	Light Sources

## Sample Viewing/Recording

Once illuminated, examining a sample with a microscope requires both focusing on the sample plane (see blue components to the right) and visualizing the resulting image (see pink components).

A microscope objective collects and magnifies light from the sample plane for imaging. On the Cerna microscope, the objective is threaded onto a nosepiece, which holds the objective at the throat depth, or the distance from the optical path to the support rail of the microscope body. This nosepiece is secured to a motorized focusing module, used for focusing the objective as well as for moving it out of the way for sample handling. To ensure a light-tight path from the objective, the microscope body comes with a bellows (not pictured).

Various modules are available for sample viewing and data collection. Trinoculars have three points of vision to view the sample directly as well as with a camera. Double camera ports redirect or split the optical path among two viewing channels. Camera tubes increase or decrease the image magnification. For data collection,

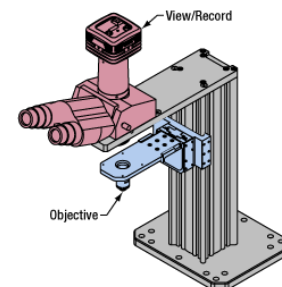

Enlarge

Click to  
Light from the sample plane is collected through an objective (blue) and viewed using trinocs or other optical ports (pink).

Thorlabs offers both cameras and photomultiplier tubes (PMTs), the latter being necessary to detect fluorescence signals for confocal microscopy. Breadboard tops provide functionality for custom-designed data collection setups. Modules are attached to the microscope body via a circular dovetail (see the *Microscope Dovetails* tab or here for details).

					
Objectives & Accessories	Objective Mounting	Sample Viewing	Cameras	PMTs	Breadboards & Body Attachments

### Sample/Experiment Mounting

Various sample and equipment mounting options are available to take advantage of the large working space of this microscope system. Large samples and ancillary equipment can be mounted via mounting platforms, which fit around the microscope body and utilize a breadboard design with regularly spaced tapped through holes. Small samples can be mounted on rigid stands (for example, see the purple component to the right), which have holders for different methods of sample preparation and data collection, such as slides, well plates, and petri dishes. For more traditional sample mounting, slides can also be mounted directly onto the microscope body via a manual XY stage. The rigid stands can translate by way of motorized stages (sold separately), while the mounting platforms contain built-in mechanics for motorized or manual translation. Rigid stands can also be mounted on top of the mounting platforms for independent and synchronized movement of multiple instruments, if you are interested in performing experiments simultaneously during microscopy.

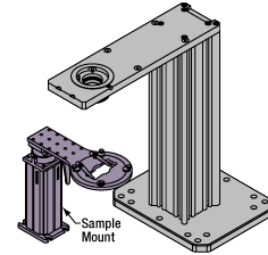

Enlarge  
The rigid stand (purple) pictured is one of various sample mounting options available.





Click to

Close

				
Translating Platforms	Rigid Stands	Translation Stages for Rigid Stands	Motorized XY Stages	Manual XY Stage

For sample viewing, Thorlabs offers trinoculars, double camera ports, and camera tubes. Light from the sample plane can be collected via cameras, photomultiplier tubes (PMTs), or custom setups using breadboard tops. Click here for additional information about viewing samples with a Cerna microscope.





#### Product Families & Web Presentations

			
Sample Viewing	Breadboards & Body Attachments	Cameras	PMTs

Close

Microscope objectives are held in the optical path of the microscope via a nosepiece. Click here for additional information about viewing a sample with a Cerna microscope.

#### Product Families & Web Presentations

				
Objectives	Objective Thread Adapters	Parfocal Length Extender	Piezo Objective Scanner	Objective Mounting

Close

Large and small experiment mounting options are available to take advantage of the large working space of this microscope. Click here for additional information

about mounting a sample for microscopy.

Product Families & Web Presentations



Translating Platforms



Rigid Stands



Translation Stages for Rigid Stands



Motorized XY Stages



Manual XY Stage

Close

Thorlabs offers various light sources for epi- and trans-illumination. Please see the full web presentation of each to determine its functionality within the Cerna microscopy platform.

Product Families & Web Presentations



Trans-Illumination Kits



Solis™ High-Power LEDs



Mounted LEDs



X-Cite® Lamps



Other Light Sources

Close

Epi-illumination illuminates the sample on the same side as the viewing apparatus. Example imaging modalities include fluorescence, confocal, and reflected light microscopy. Click here for additional information on epi-illumination with Cerna.

Product Families & Web Presentations



Epi-Illumination



Body Attachments



Light Sources

Close

Trans-illumination illuminates from the opposite side of the sample as the viewing apparatus. Example imaging modalities include brightfield, differential interference contrast (DIC), Dodt gradient contrast, oblique, and darkfield microscopy. Click here for additional information on trans-illumination with Cerna.

Product Families & Web Presentations

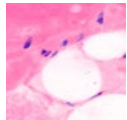

Brightfield

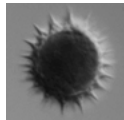

DIC

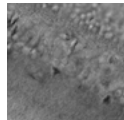

Dodt



Condensers



Condenser Mounting



Illumination Kits



Other Light Sources

Close

The microscope body provides the foundation of any Cerna microscope. The 7.74" throat depth provides a large working space for experiments. Click here for additional information about the Cerna microscope body.

Product Families & Web Presentations



Microscope Bodies



Microscope



[Hide Fixed Single-Objective Nosepieces](#)**Fixed Single-Objective Nosepieces**

- ▶ Hold One Objective in a DIY Cerna System
- ▶ CSN100: M32 x 0.75 Internal Threads, 60 mm Cage System Compatibility, and Slim Profile
- ▶ CSN1201: M32 x 0.75 Internal Threads and Slot for DIC Objective Prism
- ▶ Attach to Motorized Focusing Module for 1" of Fine Z Travel

Item #	CSN100	CSN1201
Number of Objectives	One	
Objective Threads	M32 x 0.75	
Slot for DIC Objective Prisms	No	Yes
Required Mounting Arm	None	CSA1200 Mounting Arm



Click to Enlarge  
CSN100 Nosepiece and  
M32M25S Adapter in a  
DIY Cerna® System

These nosepieces hold a single objective at the 7.74" throat depth of a DIY Cerna system. Both are directly compatible with M32 x 0.75-threaded objectives. We also offer microscope thread adapters to convert M32 x 0.75 threads to other industry-standard objective threads.



Also Required:  
ZFM Focusing  
Module

The CSN100 Single-Objective Nosepiece has a thin 0.38" profile that conserves distance along the optical path, maximizing the space available for other microscope modules. In contrast, the CSN1201 Single-Objective Nosepiece is 2.17" long, but has a slot that accepts a DIC objective prism.

The CSN100 nosepiece has four 4-40 through taps for 60 mm cage system compatibility. It can be directly attached to a motorized focusing module (available below) via six M4 counterbores. Recessed magnets on top of the nosepiece mate to the bellows included with Cerna microscope bodies with epi-illumination arms, creating a light-tight optical path between the nosepiece and the epi-illumination arm.

In comparison, the CSN1201 nosepiece requires the CSA1200 Mounting Arm (sold separately) to attach to a motorized focusing module. Recessed magnets on the CSA1200 arm mate to the bellows included with Cerna microscope bodies with epi-illumination arms, creating a light-tight optical path between the nosepiece and the epi-illumination arm.

For machining an arm utilizing non-standard nosepiece threading, consider the CSA1500 blank arm, which can also be attached to a motorized focusing module.

Part Number	Description	Price	Availability
CSN100	Nosepiece for 1 Objective, M32 x 0.75 Threads, 60 mm Cage Compatible	\$109.27	Today
CSN1201	Nosepiece for 1 Objective, M32 x 0.75 Threads, DIC Compatible	\$735.84	Today
CSA1200	Mounting Arm for CSN1201 and CSN1202 Nosepieces	\$281.14	Today

[Hide Sliding Dual-Objective Nosepieces](#)**Sliding Dual-Objective Nosepieces**

- ▶ Hold Two Objectives in a DIY Cerna System
- ▶ CSN200: Manual, M32 x 0.75 Internal Threads
- ▶ CSN210: Motorized, M32 x 0.75 Internal Threads
- ▶ Attach to Motorized Focusing Module for 1" of Fine Z Travel

Item #	CSN200	CSN210
Number of Objectives	Two	
Objective Threads	M32 x 0.75 <sup>a</sup>	
Objective Changing Mechanism	Manual	Motorized
Repeatability <sup>b</sup>	±10 µm	±5 µm
Position 1 to 2 <sup>c</sup>	-200 µm to 0	±100 µm
Required Mounting Arm	CSA1400 Mounting Arm	

These nosepieces hold two objectives in DIY Cerna systems. They are ideal for constructing systems that use a low-magnification objective to find a region of interest and a high-magnification objective to image.

Each nosepiece includes a D1T dovetail to attach to the CSA1400 Mounting Arm (sold separately). Using the arm, the nosepiece can be mounted to a motorized focusing module. Recessed magnets on the CSA1400 arm mate to the bellows included with Cerna microscope bodies with epi-illumination arms to create a light-tight optical path between the nosepiece and the epi-illumination arm. To switch and secure objectives into position, the CSN200 nosepiece uses a manual slide with detents, whereas the CSN210 nosepiece uses a precision servo motor. Please see the table to the right for more details on the performance specifications.

The motorized objective changer is controlled remotely on a PC (not included) using the included 6 ft USB cable and software; a link to download the software is also provided below. The motorized nosepiece features collision detection and will stop immediately when interference is detected. It must be rehomed before it can resume normal operation after a collision. The positions should only be changed using the motor. If it is moved manually, the nosepiece must be rehomed before it can move to either position again.

- a. We offer microscope thread adapters with external M32 x 0.75 threads to convert to other industry-standard objective threads.
- b. Maximum deviation of Position 1 after moving from Position 1 to Position 2 then back to Position 1.
- c. Maximum deviation from the center of FOV when switching from one position to another.

**Motorized Nosepiece**



Click for Details



Click for Details

The CSN210 nosepiece can be mounted in two orientations, parallel to the epi-illumination path (shown left with the CSN200), or perpendicular to the epi-illumination path (shown right with the CSN210). Each nosepiece attaches to the motorized focusing module via the CSA1400 mounting arm, which is sold separately. Note to mount the CSN210 parallel to the epi-illumination path the ZFM2030 module needs to be used. Objectives are not included with the nosepieces. Note also that the bellows shown here is longer than the standard bellows included with a microscope body.



## Software

Version 4.0 (August 16, 2018)

This software package contains the installation files for the GUI interface, driver, SDK, and support documentation. The software is compatible with Windows® 7 or 10 (64-bit) systems.



Part Number	Description	Price	Availability
CSN200	Nosepiece for 2 Objectives, M32 x 0.75 Threads	\$1,976.46	Today
CSN210	Motorized Nosepiece for 2 Objectives, M32 x 0.75 Threads	\$3,753.46	Today
CSA1400	Mounting Arm for CSN200 and CSN500 Series Nosepieces	\$312.97	Today

[Hide Retracting Dual-Objective Nosepiece](#)

## Retracting Dual-Objective Nosepiece

- ▶ Hold Two Objectives in a DIY Cerna System
- ▶ CSN1202: Manual, M25 x 0.75 Internal Threads and Slots for DIC Objective Prisms
- ▶ Attach to Motorized Focusing Module for 1" of Fine Z Travel

This nosepiece holds two objectives in DIY Cerna systems. It is ideal for constructing systems that use a low-magnification objective to find a region of interest and a high-magnification objective to image. This objective holder offers parfocal adjustment for the objectives and each position has a slot that accepts a DIC objective prism.

The nosepiece requires the CSA1200 Mounting Arm (sold separately) to attach to a motorized focusing module. The CSN1202 objective holder slides into the CSA1200 arm and can be secured with a side-located locking screw with a 2 mm hex. Recessed magnets on the CSA1200 arm mate to the bellows included with Cerna microscope bodies with epi-illumination arms to create a light-tight optical path between the nosepiece and the epi-illumination arm.

The CSN1202 nosepiece switches between objectives using a manual mechanism that retracts the objective that is not in use to avoid collisions with your sample, as demonstrated in the video below. Additionally, each objective position has an independent adjuster knob that can be used to fine tune the objectives' parfocality. To help ensure the objectives' relative centration, the front objective position has three 2 mm hex adjustment screws, arranged 120° apart, which adjust that objective's transverse position.

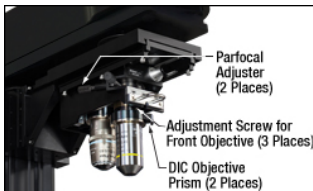

Click to Enlarge

The CSN1202 nosepiece retracts the objective that is not in use. It attaches to the motorized focusing module via the CSA1200 mounting arm, which is sold separately. For clarity, the nosepiece is shown here with objectives and objective prisms installed; these items are not included with the nosepiece.

Item #	CSN1202
Number of Objectives	Two
Objective Threads	M25 x 0.75 <sup>a</sup>
Objective Changing Mechanism	Manual
Per-Objective Parfocal Adjusters	Yes
Slots for DIC Objective Prisms	Yes
Required Mounting Arm	CSA1200 Mounting Arm

- a. Our RMSA1 thread adapter converts M25 x 0.75 threads to RMS threads. Please take care to not overthread objectives when using this and other ring-type thread adapters.



Part Number	Description	Price	Availability
CSN1202	Nosepiece for 2 Objectives, M25 x 0.75 Threads	\$1,982.44	Today
CSA1200	Mounting Arm for CSN1201 and CSN1202 Nosepieces	\$281.14	Today

[Hide Rotating Quintuple-Objective Nosepieces](#)

## Rotating Quintuple-Objective Nosepieces



Click to Enlarge  
The CSN510 Nosepiece mounted with the CSA1400 arm in a DIY Cerna System.

- ▶ Hold Five Objectives in a DIY Cerna System with a 7.74" Throat Depth
- ▶ CSN500: M25 x 0.75 Internal Threads
- ▶ CSN510: RMS Internal Threads
- ▶ Attach to Motorized Focusing Module for 1" of Fine Z Travel

These nosepieces hold five objectives in DIY Cerna systems. They are ideal for constructing systems that require multiple low- and high-magnification objectives. The objective turret's housing and threads are made from lead-free bronze, with an aluminum back plate.

The precision detent mechanism is designed with a hardened 440C stainless steel ball on a cantilever spring that engages the grooves machined into the bronze housing. The detent mechanism can position the objective lenses with a bi-directional repeatability of  $\pm 40 \mu\text{m}$ . The table to the right gives performance specifications for the turrets when integrated into well aligned systems, where all components are aligned horizontally and vertically to the optical axis. Every nosepiece is tested and shipped with a data sheet.

The CSN500 nosepiece is compatible with M25 x 0.75-threaded objectives, while the CSN510 accepts RMS (0.800"-36)-threaded objectives. We do not recommend using thread adapters with these holders because centricity misalignments may occur.

Each nosepiece has a male D1T dovetail and can be attached to a motorized focusing module via the CSA1400 Mounting Arm (sold separately). Recessed magnets on the CSA1400 arm mate to the bellows included with Cerna microscope bodies with epi-illumination arms, creating a light-tight optical path between the nosepiece and the epi-illumination arm. On a DIY Cerna System, the nosepiece should be mounted with the dovetail facing away, so the nosepiece tilts upward, as shown to the lower right.

For DIY imaging systems built using Thorlabs' Lens Tube and Cage Systems, we recommend the OT1 four-objective lens turret with SM1 (1.035"-40) threading. To mount the OT1 turret in a cage system, use a CP33(/M) or CP33T(/M) for a 30 mm cage system and an LCP02(/M) for a 60 mm cage system.



Click to Enlarge  
The back of each nosepiece has a D1T dovetail. This dovetail is used to attach to the CSA1400 Mounting Arm.



Click to Enlarge  
The CSN510 is shown with objectives of increasing magnification.



Click to Enlarge  
The objectives can be changed by manually rotating the front face of the nosepiece.

Item #	CSN500	CSN510
Number of Objectives	Five	
Objective Threads	M25 x 0.75	RMS
Parcentricity, Single Position <sup>a</sup>	$\pm 10 \mu\text{m}$	
Parcentricity, All Positions <sup>b</sup>	$\pm 40 \mu\text{m}$	
Parfocality, Single Position <sup>c</sup>	$\pm 2 \mu\text{m}$	
Parfocality, All Positions <sup>d</sup>	$\pm 10 \mu\text{m}$	
Required Mounting Arm	CSA1400 Mounting Arm	

- a. Maximum deviation for a single position after a full rotation of the nosepiece.  
Measured using 40X objective.
- b. Maximum deviation from center of FOV when moving from one position to the next. Measured using 4X and 40X objectives. System alignment optimized for 4X and 40X at starting position.
- c. Maximum Z axis deviation for a single position after multiple rotations. Measured using 40X objective.
- d. Maximum Z axis deviation of all positions compared to position 1. Measured using 40X objective.

Part Number	Description	Price	Availability
CSN500	Nosepiece for 5 Objectives, M25 x 0.75 Threads	\$1,039.68	Lead Time
CSN510	Nosepiece for 5 Objectives, RMS Threads	\$1,039.68	Lead Time
CSA1400	Mounting Arm for CSN200 and CSN500 Series Nosepieces	\$312.97	Today

## [Hide Piezo Objective Scanner and Paired Controller](#)

### Piezo Objective Scanner and Paired Controller

- ▶ Enables Objective Positioning and Z-Stack Acquisition with Resolution Down to 1 nm
- ▶ Travel Range: 600  $\mu\text{m}$   $\pm$  10% in Open Loop; 450  $\mu\text{m}$  in Closed Loop
- ▶ Support for Heavy Objectives up to 500 g
- ▶ Maximum Clear Aperture of  $\varnothing 29.0 \text{ mm}$  Supports Large-Field-of-View Objectives
- ▶ Requires Microscope and Objective Adapters (Sold Separately)



Click to Enlarge  
Exploded View



Click to Enlarge  
Assembled View

The scanner is installed by threading a brass adapter into the microscope's objective holder with the included spanner wrench and tightening a flexure clamp around the adapter with the included 5/64" (2 mm) hex key. The objective is attached to the scanner using a separate brass adapter and flexure clamp.

The PFM450E Piezo Objective Positioner is designed for fine focus adjustment and high-speed Z-stack acquisition. Built-in capacitive feedback sensors allow the scanner to provide 1 nm resolution in open-loop operation and 3 nm resolution in closed-loop operation, enabling active compensation for short- and long-term drifts.

In order to permit easy switching between objectives, the piezo stage is attached to the microscope and objective by independent adapters. This design choice allows the objective to be removed without disconnecting the rest of the assembly. Adapters are available for M32 x 0.75, M27 x 0.75, SM1 (1.035"-40), M26 x 0.706,

M25 x 0.75, and RMS (0.800"-36) threads. At least one microscope adapter and one objective adapter are required to install the scanner.

Each scanner is shipped with a piezo controller that has been factory calibrated to the specific scanner. Objective positioning is supported through the included standalone Kinesis® and APT™ GUIs, our ThorImage®LS image acquisition software, an externally supplied control voltage, or the MZF001 Joystick Console (sold separately). The controller offers USB and RS-232 interfaces for computer control; a BNC input for sine, sawtooth, and square wave drive signals; a BNC output that gives either positioning feedback from the scanner's built-in capacitive sensors or a signal proportional to the piezo drive voltage; and a connector for the MZF001 joystick. In addition, a DB15 connector provides signals that can be used for synchronization with external equipment.

More details on this scanner are available at its full web presentation. Please note that if installing it on the CSN200 or CSN210 Sliding Dual-Objective Nosepieces, the piezo stage and two adapters will add 11.5 mm of distance to the optical path, which will affect the objectives' parfocality. Also note that this scanner is not compatible with the CSN1202 Dual-Objective Nosepiece, as the flange on the PFMA05 Microscope Adapter will mechanically clash with the neighboring objective.

Part Number	Description	Price	Availability
PFM450E	Piezo Objective Scanner and Paired Controller	\$9,966.31	Today
PFMA01	Microscope Adapter for Piezo Objective Scanner, External M32 x 0.75 Threads	\$88.47	Today
PFMA01E	Microscope Adapter for Piezo Objective Scanner, External M32 x 0.75 Threads, Extended Flange	\$88.47	Today
PFMA03	Microscope Adapter for Piezo Objective Scanner, External M27 x 0.75 Threads	\$88.47	Today
PFMA09	Microscope Adapter for Piezo Objective Scanner, External SM1 Threads	\$88.47	Today
PFMA11	Customer Inspired! Microscope Adapter for Piezo Objective Scanner, External M26 x 0.706 Threads	\$97.39	Today
PFMA05	Microscope Adapter for Piezo Objective Scanner, External M25 x 0.75 Threads	\$88.47	Today
PFMA07	Microscope Adapter for Piezo Objective Scanner, External RMS Threads	\$88.47	Today
PFMA02	Objective Adapter for Piezo Objective Scanner, Internal M32 x 0.75 Threads	\$69.79	Today
PFMA04	Objective Adapter for Piezo Objective Scanner, Internal M27 x 0.75 Threads	\$68.45	Today
PFMA10	Objective Adapter for Piezo Objective Scanner, Internal SM1 Threads	\$68.45	Today
PFMA12	Customer Inspired! Objective Adapter for Piezo Objective Scanner, Internal M26 x 0.706 Threads	\$75.21	Today
PFMA06	Objective Adapter for Piezo Objective Scanner, Internal M25 x 0.75 Threads	\$68.45	Today
PFMA08	Objective Adapter for Piezo Objective Scanner, Internal RMS Threads	\$68.45	Today

[Hide SM2-Threaded Holder for Macro Lenses](#)

### SM2-Threaded Holder for Macro Lenses



Also Required:  
ZFM Focusing  
Module

- ▶ Nosepiece and Adapter Together Mount Nikon F-Mount Macro Lenses
- ▶ CSA2100: Internal SM2 (2.035"-40) Threads and 4-40 Taps for 60 mm Cage System
- ▶ SM2NFM: Female Nikon F-Mount and External SM2 Threads
- ▶ Attach to Motorized Focusing Module for 1" of Fine Z Travel

The CSA2100 Arm is designed to be mounted in a DIY Cerna system via the motorized focusing modules sold below. When combined with the SM2NFM Nikon F-Mount Adapter, it allows a Nikon F-Mount macro lens, or any camera lens with an F-Mount, to be mounted at the Cerna system's 7.74" throat depth.

This arm offers a slim 0.38" profile, internal SM2 (2.035"-40) threads, and four 4-40 through taps for Thorlabs' 60 mm cage system. The SM2NFM adapter has a female F-Mount that accepts a lens and external SM2 threads that mate to the nosepiece. More details on this adapter and a version with a male F-Mount are available at its full web presentation.



Click to Enlarge  
When the CSA2100 is attached to the microscope body, the internal SM2 threads and taps for 60 mm cage systems will be centered around the microscope's 7.74" throat depth.



Click to Enlarge  
In this photo, our SM2NFM Nikon F-Mount Adapter is holding a macro lens for functional imaging. Note a previous-generation CCD camera is shown.

The use of our standard SM2 threads also makes this arm compatible with any custom optical system mounted using our Ø2" lens tubes, as well as the CSA2001 D3N Dovetail Adapter.

To connect multiple macro lenses in tandem, as shown in the image to the right, consider using the M52A1 coupler to secure two M52 x 0.75-threaded lenses together.

Part Number	Description	Price	Availability
CSA2100	Arm, Internal SM2 Threads, 60 mm Cage Compatible	\$153.83	Today
SM2NFM	Adapter with External SM2 Threads and Nikon Female F-Mount Ring	\$98.75	Lead Time

[Hide Motorized Focusing Modules with 1" Travel](#)

### Motorized Focusing Modules with 1" Travel

- ▶ Provides Motorized Focusing Adjustment over 1" Travel Range

Motorized Translation Stage Specifications <sup>a</sup>

- ▶ 95 mm Dovetail Clamp on Back Connects to Microscope Body
- ▶ Includes Six M4 Cap Screws for Attaching Objective Nosepiece or Mounting Arm
- ▶ Aligns Optical Port of Nosepiece at 7.74" Throat Depth of DIY Cerna System
- ▶ Operated by MCM3001 3-Axis Controller (Sold Separately)

Our Motorized Focusing Modules provide 1" of fine, variable-speed travel along the Z axis for optics in a DIY Cerna system. Each module consists of a 95 mm dovetail clamp that connects to the microscope body, a motorized translation stage, and a mounting bracket with six M4 tapped holes. As shown in the image below, these six M4 taps are spaced to directly mate with the M4 counterbores on our objective nosepieces or mounting arms. A permanently attached 6' (1.8 m) cable connects the module to our MCM3001 3-Axis Controller (sold separately below).

We offer two versions of these stepper motor modules in order to allow the user to mount the nosepiece in whatever manner makes the most efficient use of space. As shown in the drawing below, a nosepiece or arm that is mounted to the ZFM2020 Motorized Module will have one surface in the same plane as the edge of the module. Since this module can be secured to the microscope body in either of two orientations, both of which are shown in the image below, the nosepiece can be positioned at the top or the bottom. In comparison, a nosepiece or arm that is mounted to the ZFM2030 Motorized Module will have one surface in the plane that bisects the module, which is 1.5" away from the module's edge.

If purchasing a motorized focusing module for the CSN200 or CSN210 Sliding Dual-Objective Nosepieces (described above), it is strongly recommended to choose the ZFM2030 module. The CSA1400 Mounting Arm, which is used to attach this nosepiece to the motorized focusing module, will mechanically clash with the ZFM2020 module in most mounting configurations.

When any of the nosepieces available above is used with one of these modules, its optical port will be aligned at the 7.74" throat depth of the DIY Cerna system. The ZFM2020 and ZFM2030 modules use the same motorized translation stage; its specifications are given in the table to the right.

<b>Travel Range</b>	1" (25.4 mm)
<b>Bidirectional Repeatability</b>	1 μm
<b>Backlash</b>	1 μm
<b>Minimum Achievable Incremental Movement</b>	100 nm
<b>Minimum Achievable Repeatable Movement</b>	200 nm
<b>Velocity (Max)</b>	7 mm/s
<b>Acceleration (Max)</b>	11 mm/s <sup>2</sup>
<b>Cable Length</b>	6' (1.8 m)
<b>Pin Diagram</b>	<a href="#">Click to View</a>
<b>Load Capacity</b>	
<b>Stage Mounted to Vertical Rail<sup>b</sup></b>	Recommended: ≤10 lbs (4.5 kg) Maximum: 10 lbs (4.5 kg)
<b>Stage Mounted to Horizontal Rail</b>	Recommended: ≤33.5 lbs (15.2 kg) Maximum: 42 lbs (19.1 kg)
<b>Stepper Motor Specifications</b>	

- The ZFM2020 and ZFM2030 modules use the same motorized translation stage (Operated by MCM3001, Sold Separately).
- This is the orientation shown in the pictures below.



[Click to Enlarge](#)  
Our motorized focusing modules attach to objective nosepieces using six M4 cap screws.



[Click to Enlarge](#)  
The ZFM2020 module has two possible orientations, creating space along the optical path for an objective attached to a nosepiece.

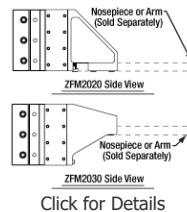

[Click for Details](#)

When using the ZFM2020 module, the surface of the nosepiece or arm will be flush with the bottom (or top) of the module.

When using the ZFM2030 module, the surface of the nosepiece or arm will be at the middle of

Part Number	Description	Price	Availability
ZFM2020	Motorized Module with 1" Travel for Edge-Mounted Arms	\$2,010.41	Today
ZFM2030	Motorized Module with 1" Travel for Middle-Mounted Arms	\$2,010.41	Today

#### [Hide Motion Controller for Cerna Components with 1" Travel Range](#)

### Motion Controller for Cerna Components with 1" Travel Range

- ▶ Designed for Cerna Components with 1" Motorized Travel
- ▶ Knobs Provide Hand-Operated Control for up to Three Axes
- ▶ Each Axis can be Individually Disabled to Prevent Unintended Movements or to Retain a Position
- ▶ Adjust Translation Speed via Top-Located Knob

<b>Compatible Stages</b>
Motorized Focusing Modules
Translation Stages for Rigid Stands
<b>Controller Specifications</b>
<b>Compatible Motor Specifications</b>

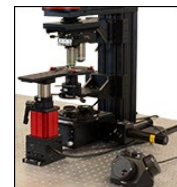

[Click to Enlarge](#)  
MCM3001 Being Used to Control Both Axes of the PLS-XY and a ZFM2020 Focusing Module

The MCM3001 3-Axis Controller consists of a hand-operated knob box and a separate controller, as shown in the photo to the right.

Each side face of the knob box includes a rotating knob and a push-button switch that are dedicated to a single axis. The push-button switch enables and disables the axis, and is lit in green when the axis is enabled. Disabling the axis lets the user preserve a position or prevent accidental movements. A smaller knob on the top face adjusts the amount of translation per rotation of the knob (see the Controller Specifications table for details).

Since each MCM3001 controller has three channels, you only need to purchase enough channels for each of the modules you intend to drive. For example, a Cerna

microscope equipped with a ZFM2020 Motorized Focusing Module (which has one axis) and a PLS-XY Translation Stage (two axes) would only require one MCM3001 controller.

The MCM3001 is compatible with motorized Cerna components that have a travel range of 1", such as our Motorized Focusing Modules and Translation Stages for Rigid Stands; see the Compatible Motor Specifications table for use with alternate motorized products. For components with a 2" travel range, such as our Translating Platforms, the MCM3002 controller should be used instead. If you would like a controller configured to drive more than one type of stage, please contact Tech Support.

SDK and LabVIEW examples are also available by contacting Tech Support.

Part Number	Description	Price	Availability
MCM3001	Three-Channel Controller and Knob Box for 1" Cerna Travel Stages	\$3,368.64	Today

